

EMERGENCY LIGHTING

LIGHT YOUR WAY
KEEP PEOPLE SAFE



EXIT





▼ PRODUCT ON SALE

Emergency Exit
Emergency Light
Emergency Driver

▼ SERVICE AND SAFETY

Full test before shipment
Professional QC Team

▼ FUTURE

IOT Wireless System
Intelligent Lighting Solutions
ODM Service

ABOUT US

Founded on the principles of cost-effective and reliable service, we seek to outfit our customers with only the highest-quality products, and to tailor our efforts to each client's needs and preferences. We have manufactured and supplied Emergency Lighting to the European and Australian Market and get so many affirmative feedbacks since we established from August 20th 2017.

We believe in exceeding the minimum requirement of effort in all aspects of our business, and are constantly working to improve our knowledge and effectiveness within our field. We will be more and more professional and experienced to help our customer.



Epowertech

30+

More than 30 tests/testing facilities

- Thermal Test
- AC Power Source
- Power Meter
- Oven
- Aging Test
- IPX5/X6 Test
- IPX7 Test
- Lifespan Test
- Cord Anchorage Test
- Suspension Test
- DC Power Test
- Electronic Load Test
- Electronic Balance
- Digital Multimeter
- Oscilloscope
- 3D Printer
- IES Test
- Water-proof Test
- Dust-proof Test
- Glow-wire Test
- Needle-flame Test
- Salt Spray Test
- Drop Test
- Draught-proof Test
- Anti-UV Test
- Integrating Sphere
- Safety Test
- Touch Current Test
- Constant Temperature & Humidity Test
- RoHS Test



Certificate



Corporate culture



EUROPE

Exit Sign | EM Light | EM Driver



P02 EPE-EX1



P04 EPE-EX2



P06 EPE-EX3



P08 EPE-EX4



P10 EPE-EX5



P12 EPE-EX6



P14 EPE-EX7



P16 EPE-EX8



P19 EPE-3W-EM



P22 EPE-EM2



P24 EPE-EM2-IP



P26 EPE-EM3



P28 EPE-EM3B



P30 EPE-EM4



P32 EPE-EM5



P34 EPE-EM5-IP



P36 EPE-EM6



P38 EPE-EM6-IP



P40 EPE-EM6B



P42 EPE-EM7



P44 EPE-EM8



P46 EPE-EM9



P48 EPE-EM11



P50 EPE-EM12



P53 EPE-ED1

EUROPE

Exit Sign | EM Light | EM Driver



P55 EPE-ED2



P57 EPE-ED3



P59 EPE-ED6



P61 EPE-ED7



P63 EPE-ED9

OCEANIA

Exit Sign | EM Light



P65 EPA-EX1



P67 EPA-EX2



P69 EPA-EX4A



P71 EPE-3W-EM



P73 EPE-3W-EM-SB

AMERICA

Exit Sign | EM Light | EM Driver



P76 EPU-EX1



P78 EPU-EX2



P80 EPU-EX3



P82 EPU-EX4



P84 EPU-CB1



P86 EPU-EM1



P88 EPU-EM1-IP



P90 EPU-EM2



P92 EPU-ED1



P94 EPU-ED2

EPE-EX1 | LED Exit Sign



- Compact and decorative design.
- Single and double face universal.
- Replaceable pictogram legends.
- LiFePO4 battery, long life time.



▼ Model List

Model	Input Voltage	Mains/ Emergency Power	Charge/ Discharge Duration	Battery	Test Mode
EPE-EX1-AT-3H	220-240VAC	3W Max/ 1W Max	24H/ ≥3H	LiFePO4 6.4V 600mAh	Auto Test
EPE-EX1-MT-3H	220-240VAC	3W Max/ 1W Max	24H/ ≥3H	LiFePO4 6.4V 600mAh	Manual Test
EPE-EX1-DA-3H	220-240VAC	3W Max/ 1W Max	24H/ ≥3H	LiFePO4 6.4V 600mAh	DALI
EPE-EX1-AT-NC-3H	220-240VAC	3W Max/ 1W Max	24H/ ≥3H	Ni-Cd 3.6V 900mAh	Auto Test
EPE-EX1-MT-NC-3H	220-240VAC	3W Max/ 1W Max	24H/ ≥3H	Ni-Cd 3.6V 900mAh	Manual Test

*CBS version is available upon request.

▼ Dimensions unit:mm

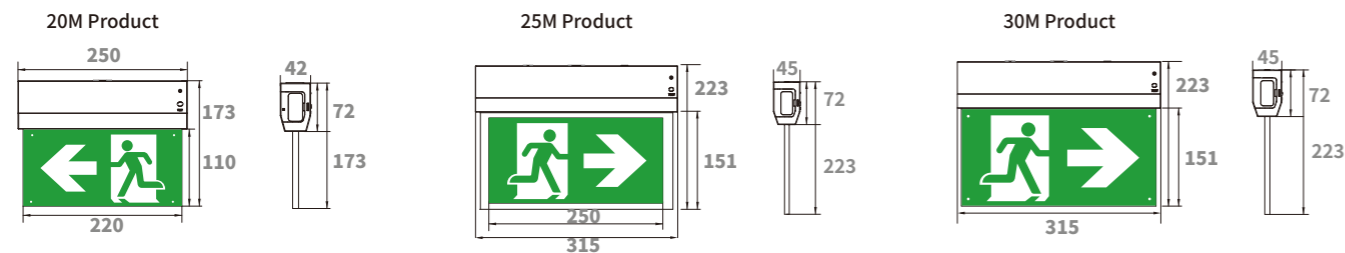

▼ Mounting Options

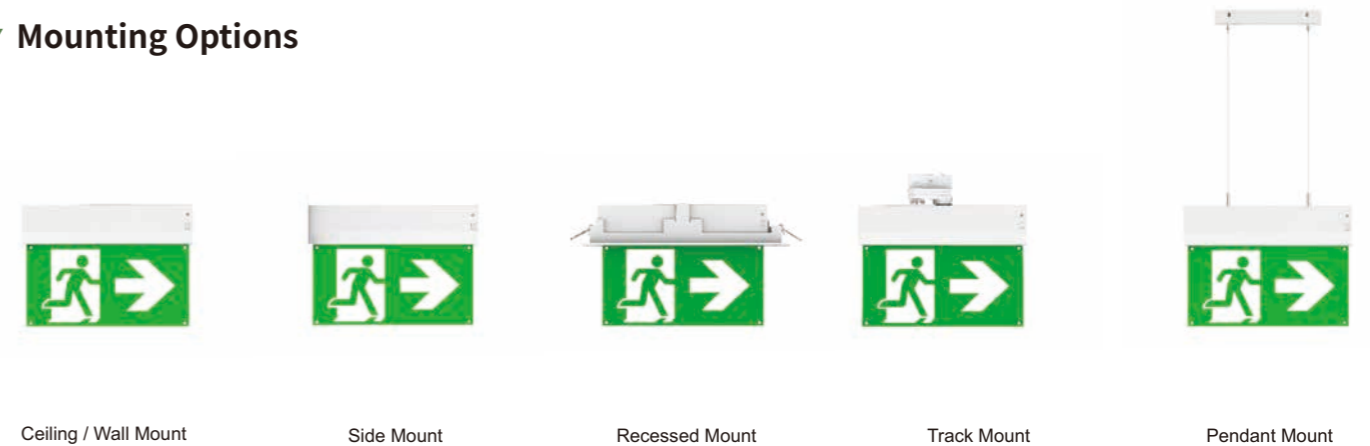

EPE-EX2 | LED Exit Sign



- Compact and decorative design.
- Aluminum housing with high grade acrylic panel.
- LED Exit Sign with high luminance performance.
- LiFePO4 battery, long life time.



▼ Model List

Model	Input Voltage	Mains/ Emergency Power	Charge/ Discharge Duration	Battery	Test Mode
EPE-EX2-AT-3H	220-240VAC	3W Max/ 1W Max	24H/ ≥3H	LiFePO4 6.4V 600mAh	Auto Test
EPE-EX2-MT-3H	220-240VAC	3W Max/ 1W Max	24H/ ≥3H	LiFePO4 6.4V 600mAh	Manual Test
EPE-EX2-DA-3H	220-240VAC	3W Max/ 1W Max	24H/ ≥3H	LiFePO4 6.4V 600mAh	DALI

*CBS version is available upon request

▼ Dimensions unit:mm

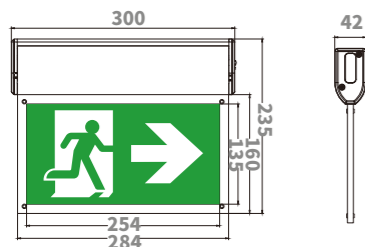

▼ Mounting Options



Side Mounting



Ceiling Mounting



Wall Mounting



EPE-EX3 | LED Exit Box



- Optional pictogram legends.
- LiFePO4 battery, long life time.
- Maintained and non-maintained.
- Suitable for wall mounting.
- Steel housing construction.



▼ Model List

Model	Input Voltage	Mains/ Emergency Power	Charge/ Discharge Duration	Battery	Test Mode
EPE-EX3-AT-3H	220-240VAC	3W Max/ 1W Max	24H/ ≥3H	LiFePO4 6.4V 600mAh	Auto Test
EPE-EX3-MT-3H	220-240VAC	3W Max/ 1W Max	24H/ ≥3H	LiFePO4 6.4V 600mAh	Manual Test
EPE-EX3-DA-3H	220-240VAC	3W Max/ 1W Max	24H/ ≥3H	LiFePO4 6.4V 600mAh	DALI

▼ Dimensions unit:mm

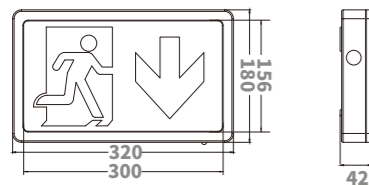

▼ Appearance



EPE-EX4 | LED Exit sign



- 70m viewing distance.
- Suitable for tall and spacious application.
- Test button and LED indicator.
- High quality LiFePO4 battery, long life time.
- Quick and easy installation of multiple mounting.



▼ Model List

Model	Input Voltage	Mains/ Emergency Power	Charge/ Discharge Duration	Battery	Test Mode
EPE-EX4-AT-3H	220-240VAC	22W Max/ 10W Max	24H/ ≥3H	Li-ion 11.1V2200mAh	Auto Test
EPE-EX4-MT-3H	220-240VAC	22W Max/ 10W Max	24H/ ≥3H	Li-ion 11.1V5000mAh	Manual Test
EPE-EX4-DA-3H	220-240VAC	22W Max/ 10W Max	24H/ ≥3H	Li-ion 11.1V5000mAh	DALI

▼ Dimensions unit:mm

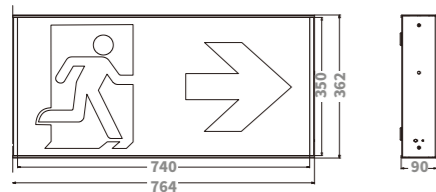

▼ Mounting Options



EPE-EX5 | Waterproof LED Exit Sign



- PC material with IP65 rating.
- Optional interchangeable legends.
- Maintained & non-maintained mode.
- High quality LiFePO4 battery, long life time.
- Surface & recessed mounting.



▼ Model List

Model	Input Voltage	Mains/ Emergency Power	Charge/ Discharge Duration	Battery	Test Mode
EPE-EX5-ST-AT-3H	200-240VAC	2W Max/ 1W Max	24H/ ≥3H	LiFePO4 6.4V 1500mAh	Auto Test
EPE-EX5-ST-MT-3H	200-240VAC	2W Max/ 1W Max	24H/ ≥3H	LiFePO4 6.4V 1500mAh	Manual Test
EPE-EX5-ST-DA-3H	200-240VAC	2W Max/ 1W Max	24H/ ≥3H	LiFePO4 6.4V 1500mAh	DALI

▼ Dimensions unit:mm

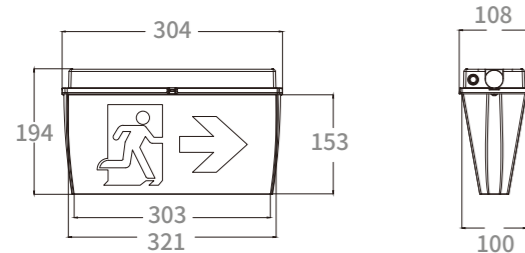

▼ Appearance



EPE-EX6 | Rotatable LED Exit Sign



- 180° Rotatable design.
 - PC cover, PMMA board.
 - High quality acrylic panel with interchangeable legends.
 - Energy-saving cinema mode optional.
 - Li-ion & LiFePO4 battery.
- Wall/ceiling/recessed/pendent and track installation.



▼ Model List

Model	Input Voltage	Mains/ Emergency Power	Charge/ Discharge Duration	Battery	Test Mode
EPE-EX6-AT-3H	220-240VAC	3W Max/ 1W Max	24H/ ≥3H	Li-ion 3.7V 1200mAh	Auto Test
EPE-EX6-MT-3H	220-240VAC	3W Max/ 1W Max	24H/ ≥3H	Li-ion 3.7V 1200mAh	Manual Test
EPE-EX6-DA-3H	220-240VAC	3W Max/ 1W Max	24H/ ≥3H	Li-ion 3.7V 1200mAh	DALI
EPE-EX6-LI-AT-3H	220-240VAC	3W Max/ 1W Max	24H/ ≥3H	LiFePO4 3.2V 1500mAh	Auto Test
EPE-EX6-LI-MT-3H	220-240VAC	3W Max/ 1W Max	24H/ ≥3H	LiFePO4 3.2V 1500mAh	Manual Test
EPE-EX6-LI-DA-3H	220-240VAC	3W Max/ 1W Max	24H/ ≥3H	LiFePO4 3.2V 1500mAh	DALI
EPE-EX6C-LI-AT-3H	220-240VAC	3W Max/ 1W Max	24H/ ≥3H	LiFePO4 3.2V 1500mAh	Auto Test
EPE-EX6C-LI-MT-3H	220-240VAC	3W Max/ 1W Max	24H/ ≥3H	LiFePO4 3.2V 1500mAh	Manual Test
EPE-EX6C-LI-DA-3H	220-240VAC	3W Max/ 1W Max	24H/ ≥3H	LiFePO4 3.2V 1500mAh	DALI

*CBS version is available upon request.

▼ Dimensions unit:mm

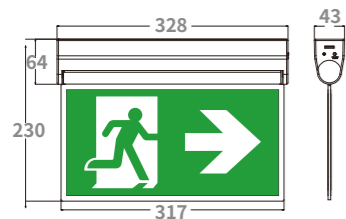

▼ Appearance



▼ Mounting Options



Ceiling / Wall Mount



Recessed Mount



Track Mount



Pendant Mount

EPE-EX7 | Slimline LED Combo Exit Box



- Exit box with downlighter.
- PC housing with IP40 and IK07 rating.
- Light guide plate distributes light evenly.
- Wall mounting/Recessed mounting only with 4 springs.
- LiFePO4 battery, long life time.
- Multi-use applications including corridors, walkways, commercial spaces, primary escape routes and stairways.



▼ Model List

Model	Input Voltage	Mains/ Emergency Power	Charge/ Discharge Duration	Battery	Test Mode
EPE-EX7-AT-3H	200-240VAC	5W Max/ 1W Max/ 0.5W Max	24H/ ≥3H	LiFePO4 3.2V1500mAh	Auto Test
EPE-EX7-MT-3H	200-240VAC	5W Max/ 1W Max/ 0.5W Max	24H/ ≥3H	LiFePO4 3.2V1500mAh	Manual Test
EPE-EX7-DA-3H	200-240VAC	5W Max/ 1W Max/ 0.5W Max	24H/ ≥3H	LiFePO4 3.2V1500mAh	DALI

▼ Dimensions unit:mm

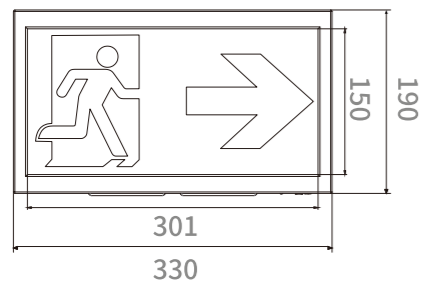

▼ Mounting Options



Wall Mount



Recessed Mount

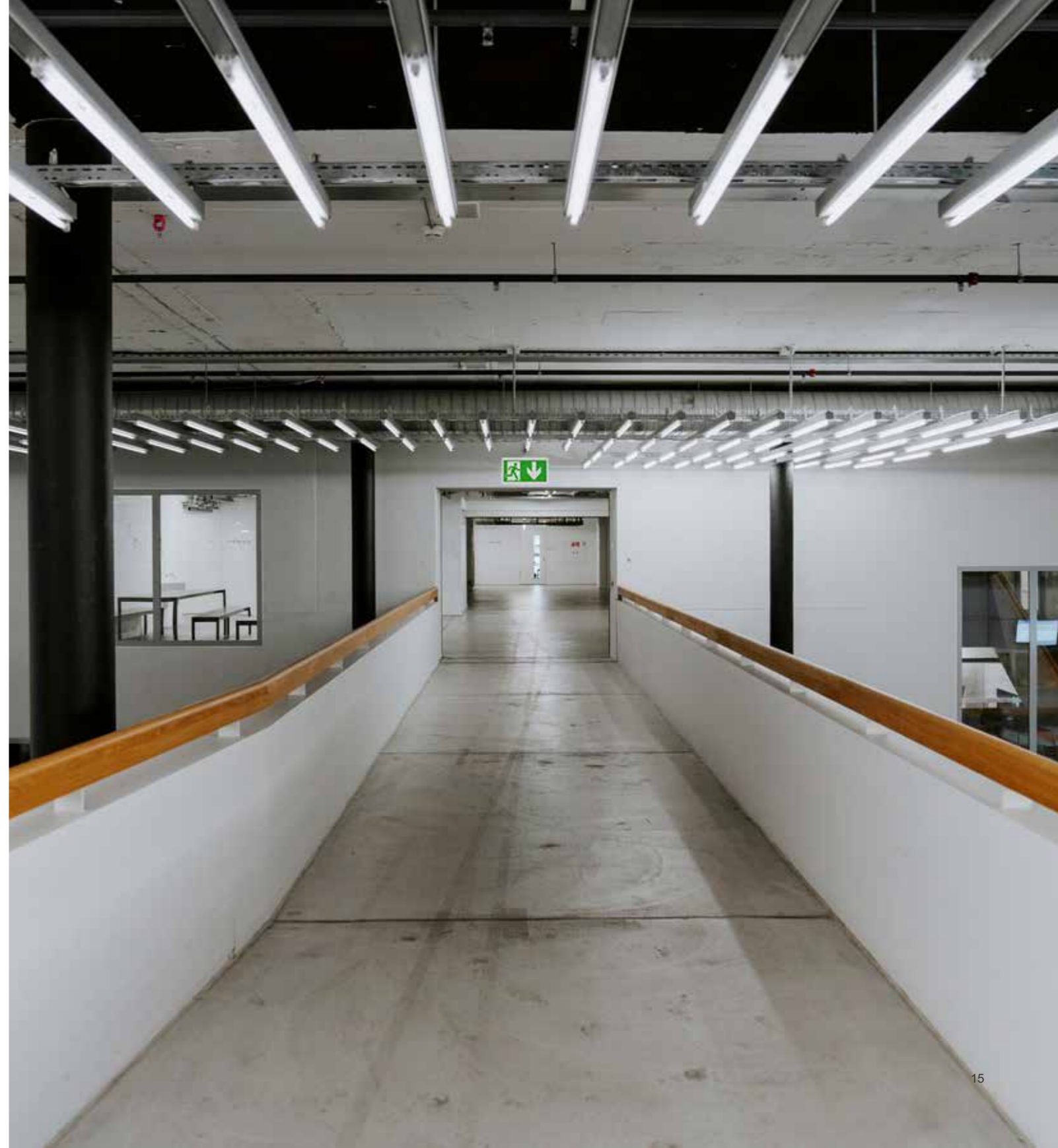

EPE-EX8 | Led Emergency Signage



- LiFePO4 battery, long life time.
- Signage with downlighter.
- Maintained signage with various legend options.
- Non-maintained downlighter spot fire-extinguishers, first-aid kit, AED immediately at power failure.



▼ Model List

Model	Input Voltage	Mains/ Emergency Power	Charge/ Discharge Duration	Battery	Test Mode
EPE-EX8-AT-3H	220-240VAC	5W Max/ 0.5W Max/ 1W Max	24H/ ≥3H	LiFePO4 3.2V1500mAh	Auto Test
EPE-EX8-MT-3H	220-240VAC	5W Max/ 0.5W Max/ 1W Max	24H/ ≥3H	LiFePO4 3.2V1500mAh	Manual Test
EPE-EX8-DA-3H	220-240VAC	5W Max/ 0.5W Max/ 1W Max	24H/ ≥3H	LiFePO4 3.2V1500mAh	DALI

▼ Dimensions unit:mm

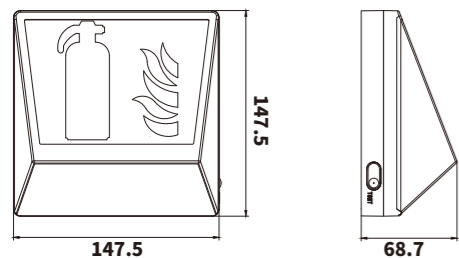

EUROPEAN EMERGENCY LIGHT

EPE-3W-EM | LED Emergency Downlight



- Round lens for open area application.
- Oval lens for escape route application.
- LiFePO4 battery, long life time.
- High power & efficiency LED.
- 80mm adapter ring for bigger cuthole included.



Model List

Model	Input Voltage	Mains/ Emergency Power	Charge/ Discharge Duration	Battery	Test Mode
EPE-3W-EM-AT-3H	200-240VAC	220lm @3.5W Max/ 2W Max	24H/ ≥3H	LiFePO4 6.4V1500mAh	Auto Test
EPE-3W-EM-MT-3H	200-240VAC	220lm @3.5W Max/ 2W Max	24H/ ≥3H	LiFePO4 6.4V1500mAh	Manual Test
EPE-3W-EM-DA-3H	200-240VAC	220lm @3.5W Max/ 2W Max	24H/ ≥3H	LiFePO4 6.4V1500mAh	DALI
EPE-3W-EM-NC-AT-3H	200-240VAC	100lm @3.5W Max/ 2W Max	24H/ ≥3H	Ni-Cd 3.6V1500mAh	Auto Test
EPE-3W-EM-NC-MT-3H	200-240VAC	100lm @3.5W Max/ 2W Max	24H/ ≥3H	Ni-Cd 3.6V1500mAh	Manual Test
EPE-3W-EM-NC-DA-3H	200-240VAC	100lm @3.5W Max/ 2W Max	24H/ ≥3H	Ni-Cd 3.6V1500mAh	DALI

Dimensions unit:mm

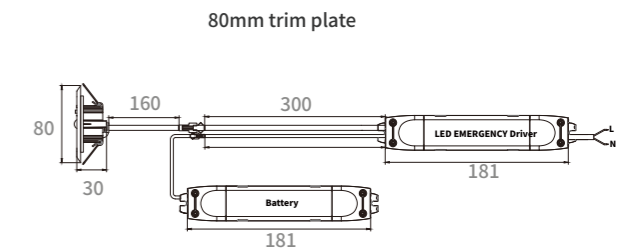
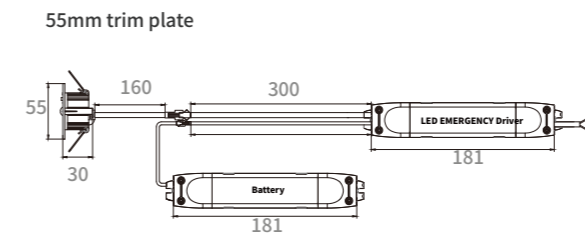

EPE-3W-EM | LED Emergency Downlight

▼ Square Trim Plate

- Separated design, drivers & battery kit replaceable.
- Interchangeable round/oval lens.
- LiFePO4 battery, long life time.



▼ Dimensions unit:mm

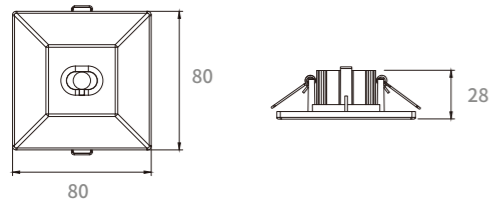

▼ Appearance

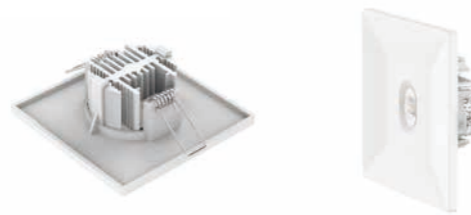

▼ Photometric Data

Oval lens for escape route application

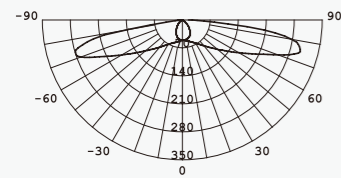

Beam angle: C0°:165° C90°: 68°

Round lens for open area application

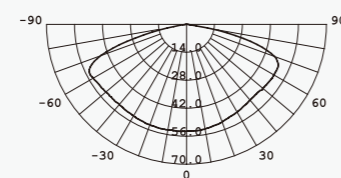

Beam angle: 148°



EPE-EM2 | LED Emergency Downlight



- Modular design, surface or recessed mounted 2 in one.
- Interchangeable round or oval lens.
- High power & efficiency LED.



Model List

Model	Input Voltage	Mains/ Emergency Power	Charge/ Discharge Duration	Battery	Test Mode
EPE-EM2-ST-AT-3H	200-240VAC	240lm @3.5W Max/ 2W Max	24H/ ≥3H	LiFePO4 6.4V 1500mAh	Auto Test
EPE-EM2-ST-MT-3H	200-240VAC	240lm @3.5W Max/ 2W Max	24H/ ≥3H	LiFePO4 6.4V 1500mAh	Manual Test
EPE-EM2-ST-DA-3H	200-240VAC	240lm @3.5W Max/ 2W Max	24H/ ≥3H	LiFePO4 6.4V 1500mAh	DALI
EPE-EM2-HO-AT-3H	200-240VAC	450lm @6W Max/ 4W Max	24H/ ≥3H	LiFePO4 9.6V 1500mAh	Auto Test
EPE-EM2-HO-MT-3H	200-240VAC	450lm @6W Max/ 4W Max	24H/ ≥3H	LiFePO4 9.6V 1500mAh	Manual Test
EPE-EM2-HO-DA-3H	200-240VAC	450lm @6W Max/ 4W Max	24H/ ≥3H	LiFePO4 9.6V 1500mAh	DALI

*CBS version is available upon request.

Dimensions unit:mm

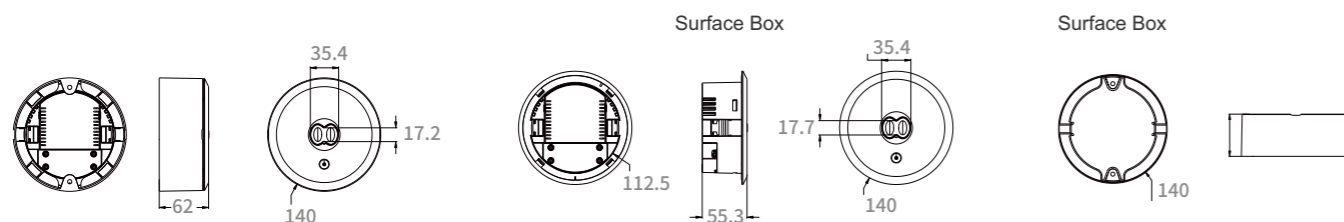

Photometric Data

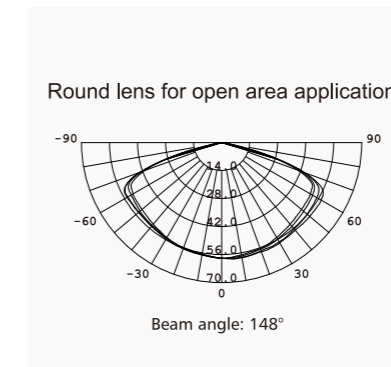
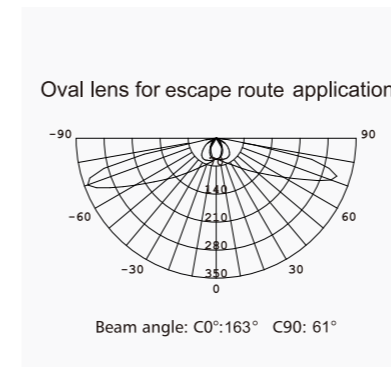

Convenient installation

- Mount surface mouting kit on the surface screws and anchors
- After wiring connection snap unit on surface mount kit
- Align the marker

EPE-EM2-IP

LED Surface Mounting Emergency Light



- Round lens for open area application.
- Oval lens for escape route application.
- Compact high performance IP65 Rated.
- High power & efficiency LED.



Model List

Model	Input Voltage	Mains/ Emergency Power	Charge/ Discharge Duration	Battery	Test Mode
EPE-EM2-HO-IP-AT-3H	200-240VAC	450lm @6W Max/ 4W Max	24H/ ≥3H	LiFePO4 9.6V1500mAh	Auto Test
EPE-EM2-HO-IP-MT-3H	200-240VAC	450lm @6W Max/ 4W Max	24H/ ≥3H	LiFePO4 9.6V1500mAh	Manual Test
EPE-EM2-HO-IP-DA-3H	200-240VAC	450lm @6W Max/ 4W Max	24H/ ≥3H	LiFePO4 9.6V1500mAh	DALI
EPE-EM2-ST-IP-AT-3H	200-240VAC	240lm @3.5W Max/ 2W Max	24H/ ≥3H	LiFePO4 6.4V1500mAh	Auto Test
EPE-EM2-ST-IP-MT-3H	200-240VAC	240lm @3.5W Max/ 2W Max	24H/ ≥3H	LiFePO4 6.4V1500mAh	Manual Test
EPE-EM2-ST-IP-DA-3H	200-240VAC	240lm @3.5W Max/ 2W Max	24H/ ≥3H	LiFePO4 6.4V1500mAh	DALI

*CBS version is available upon request.

Dimensions

unit:mm

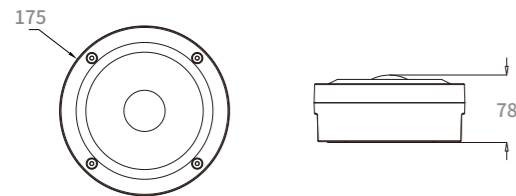

Appearance



Photometric Data

Oval lens for escape route application

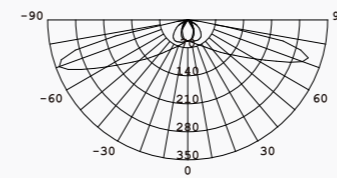

Beam angle: C0:163° C90: 61°

Round lens for open area application

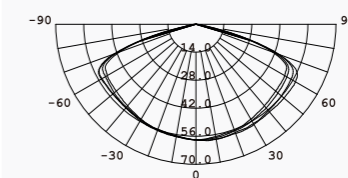

Beam angle: 148°



EPE-EM3 | LED Emergency Bulkhead



- Maintained or non-maintained selectable.
- UV resistant & optional interchangeable legends.
- IP65 Rated.
- Efficient and reliable LED light source.
- Suitable for wall/ ceiling/ recessed mounting.
- LiFePO4 battery, more stable and higher temperature performance.



Model List

Model	Input Voltage	Mains/ Emergency Power	Charge/ Discharge Duration	Battery	Test Mode
EPE-EM3-ST-AT-3H	200-240VAC	200lm @6W Max/ 2W Max	24H/ ≥3H	LiFePO4 9.6V1500mAh	Auto Test
EPE-EM3-ST-MT-3H	200-240VAC	200lm @6W Max/ 2W Max	24H/ ≥3H	LiFePO4 9.6V1500mAh	Manual Test
EPE-EM3-ST-DA-3H	200-240VAC	200lm @6W Max/ 2W Max	24H/ ≥3H	LiFePO4 9.6V1500mAh	DALI

*CBS version is available upon request.

Dimensions unit:mm

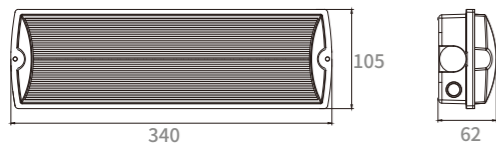

Appearance



Dimensions Unit:mm

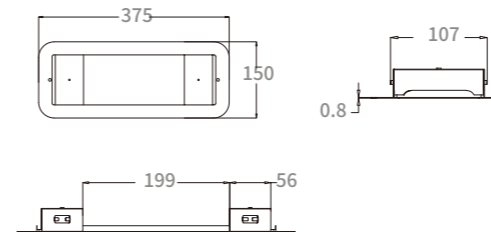

Recessed Mounting



EPE-EM3B | LED Emergency Bulkhead



- Ip65 Rated.
- Power Factor ≥ 0.9 .
- High power and high lumen output.
- Ceiling mounting/ Recessed mounting only with springs, easy installations and cost-effective.
- LiFePO4 battery with better performance and longer life time.



Model List

Model	Input Voltage	Mains/ Emergency Power	Charge/ Discharge Duration	Battery	Test Mode
EPE-EM3B-ST-AT-3H	220-240VAC	650lm @8W Max/ 4.5W Max	24H/ ≥ 3 H	LiFePO4 6.4V3200mAh	Auto Test
EPE-EM3B-ST-MT-3H	220-240VAC	650lm @8W Max/ 4.5W Max	24H/ ≥ 3 H	LiFePO4 6.4V3200mAh	Manual Test
EPE-EM3B-ST-DA-3H	220-240VAC	650lm @8W Max/ 4.5W Max	24H/ ≥ 3 H	LiFePO4 6.4V3200mAh	DALI
EPE-EM3B-HO-AT-3H	220-240VAC	1200lm @18W Max/ 8W Max	24H/ ≥ 3 H	LiFePO4 6.4V6000mAh	Auto Test
EPE-EM3B-HO-MT-3H	220-240VAC	1200lm @18W Max/ 8W Max	24H/ ≥ 3 H	LiFePO4 6.4V6000mAh	Manual Test
EPE-EM3B-HO-DA-3H	220-240VAC	1200lm @18W Max/ 8W Max	24H/ ≥ 3 H	LiFePO4 6.4V6000mAh	DALI

*CBS version is available upon request.

Dimensions unit:mm

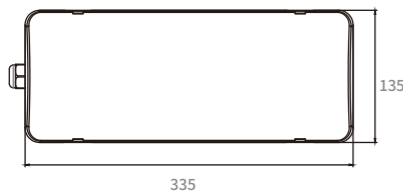

Appearance

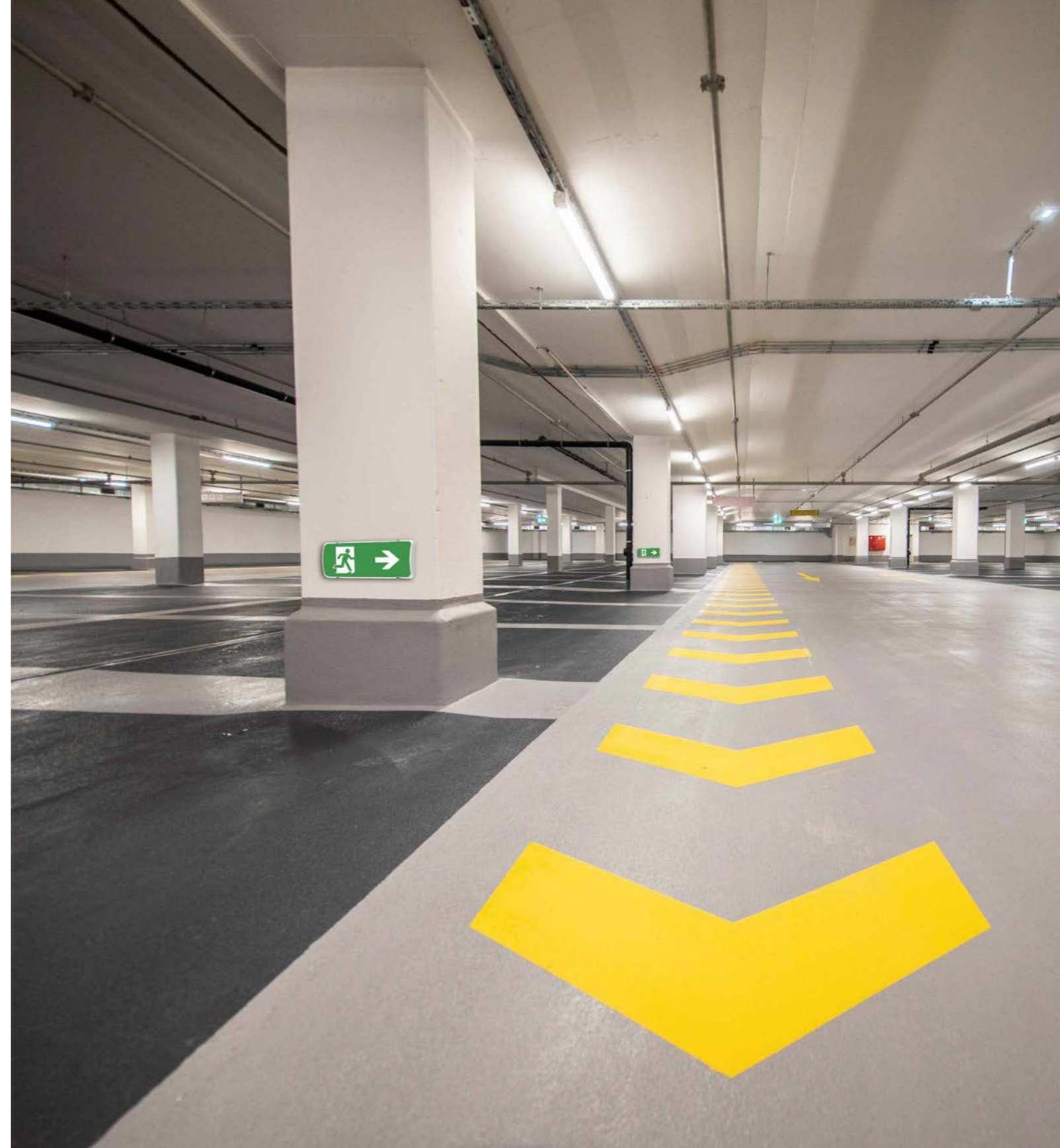

EPE-EM4 | LED Surface Mounting Emergency Light



- Slim and modern design.
- Round lens and oval lens option.
- Intelligent control available.
- Exterior LED indicator.



Model List

Model	Input Voltage	Mains/ Emergency Power	Charge/ Discharge Duration	Battery	Test Mode
EPE-EM4-ST-AT-3H	200-240VAC	220lm @3.5W Max/ 2W Max	24H/ ≥3H	LiFePO4 6.4V1500mAh	Auto Test
EPE-EM4-ST-MT-3H	200-240VAC	220lm @3.5W Max/ 2W Max	24H/ ≥3H	LiFePO4 6.4V1500mAh	Manual Test
EPE-EM4-ST-DA-3H	200-240VAC	220lm @3.5W Max/ 2W Max	24H/ ≥3H	LiFePO4 6.4V1500mAh	DALI

Dimensions unit:mm

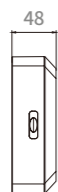
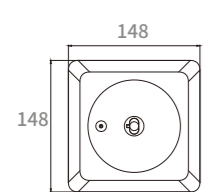

Power Feed Position:Rear & Side

Power Feed Position:Rear

Appearance



Height:48mm | Round Lens | White



Height:33mm | Oval Lens | Black

Photometric Data

Oval lens for escape route application

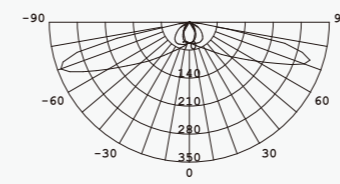

Beam angle: C0°:163° C90°:61°

Round lens for open area application

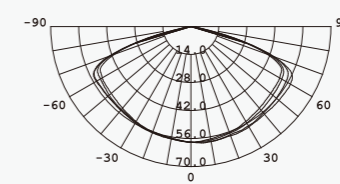

Beam angle: 148°

EPE-EM5 | LED Surface Mounting Emergency Light



- Buckle Design, easy installation.
- Round lens for open area application.
- Oval lens for escape route application.
- High power & efficiency LED.
- LiFePO4 battery, environmental-friendly, longer life time.



Model List

Model	Input Voltage	Mains/ Emergency Power	Charge/ Discharge Duration	Battery	Test Mode
EPE-EM5-ST-AT-3H	200-240VAC	240lm @3.5W Max/ 2W Max	24H/ ≥3H	LiFePO4 6.4V1500mAh	Auto Test
EPE-EM5-ST-MT-3H	200-240VAC	240lm @3.5W Max/ 2W Max	24H/ ≥3H	LiFePO4 6.4V1500mAh	Manual Test
EPE-EM5-ST-DA-3H	200-240VAC	240lm @3.5W Max/ 2W Max	24H/ ≥3H	LiFePO4 6.4V1500mAh	DALI
EPE-EM5-HO-AT-3H	200-240VAC	450lm @6W Max/ 4W Max	24H/ ≥3H	LiFePO4 9.6V1500mAh	Auto Test
EPE-EM5-HO-MT-3H	200-240VAC	450lm @6W Max/ 4W Max	24H/ ≥3H	LiFePO4 9.6V1500mAh	Manual Test
EPE-EM5-HO-DA-3H	200-240VAC	450lm @6W Max/ 4W Max	24H/ ≥3H	LiFePO4 9.6V1500mAh	DALI

Dimensions unit:mm

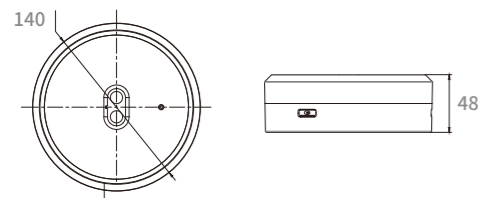

Appearance



Photometric Data

Oval lens for escape route application

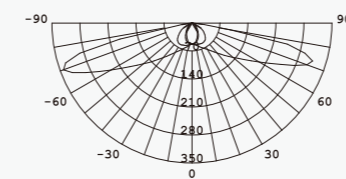

Beam angle: C0°: 163° C90°: 61°

Round lens for open area application

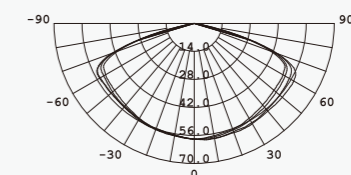

Beam angle: 148°

EPE-EM5-IP

LED Surface Mounting Emergency Light



- Oval lens for escape route application.
- Round lens for open area application.
- Compact high performance IP65 Rated.
- High power & efficiency LED.



▼ Model List

Model	Input Voltage	Mains/ Emergency Power	Charge/ Discharge Duration	Battery	Test Mode
EPE-EM5-ST-IP-AT-3H	200-240VAC	240lm @3.5W Max/ 2W Max	24H/ ≥3H	LiFePO4 6.4V1500mAh	Auto Test
EPE-EM5-ST-IP-MT-3H	200-240VAC	240lm @3.5W Max/ 2W Max	24H/ ≥3H	LiFePO4 6.4V1500mAh	Manual Test
EPE-EM5-ST-IP-DA-3H	200-240VAC	240lm @3.5W Max/ 2W Max	24H/ ≥3H	LiFePO4 6.4V1500mAh	DALI
EPE-EM5-HO-IP-AT-3H	200-240VAC	450lm @6W Max/ 4W Max	24H/ ≥3H	LiFePO4 9.6V1500mAh	Auto Test
EPE-EM5-HO-IP-MT-3H	200-240VAC	450lm @6W Max/ 4W Max	24H/ ≥3H	LiFePO4 9.6V1500mAh	Manual Test
EPE-EM5-HO-IP-DA-3H	200-240VAC	450lm @6W Max/ 4W Max	24H/ ≥3H	LiFePO4 9.6V1500mAh	DALI

▼ Dimensions unit:mm

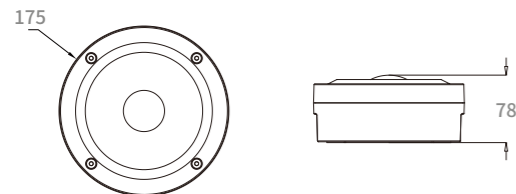

▼ Appearance



EPE-EM6 | LED Twin Spot Emergency Light



- Two adjustable LED lamp heads.
- Round lens and oval lens optional.
- Self-contained for 1 or 3 hours emergency backup.
- LED indicator light and test switch.



▼ Model List

Model	Input Voltage	Mains/ Emergency Power	Charge/ Discharge Duration	Battery	Test Mode
EPE-EM6-ST-AT-TL-3H	220-240VAC	200lm @2.5W Max/ 2W Max	24H/ ≥3H	Li-ion 3.7V/2200mAh	Auto Test
EPE-EM6-ST-MT-TL-3H	220-240VAC	200lm @2.5W Max/ 2W Max	24H/ ≥3H	Li-ion 3.7V/2200mAh	Manual Test
EPE-EM6-ST-DA-TL-3H	220-240VAC	200lm @2.5W Max/ 2W Max	24H/ ≥3H	Li-ion 3.7V/2200mAh	DALI
EPE-EM6-HO-AT-TL-3H	220-240VAC	400lm @4W Max/ 4W Max	24H/ ≥3H	Li-ion 3.7V/4400mAh	Auto Test
EPE-EM6-HO-MT-TL-3H	220-240VAC	400lm @4W Max/ 4W Max	24H/ ≥3H	Li-ion 3.7V/4400mAh	Manual Test
EPE-EM6-HO-DA-TL-3H	220-240VAC	400lm @4W Max/ 4W Max	24H/ ≥3H	Li-ion 3.7V/4400mAh	DALI

▼ Dimensions unit:mm

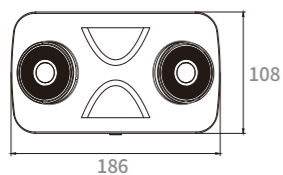

▼ Lens



Oval Lens

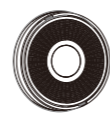

Round Lens



EPE-EM6-IP | IP65 LED Twin Spot Emergency Light



- Two adjustable LED lamp heads.
- Round lens and oval lens optional.
- Self-contained for 1 or 3 hours emergency backup.
- LED indicator light and test switch.
- IP65 Rating.



Model List

Model	Input Voltage	Mains/ Emergency Power	Charge/ Discharge Duration	Battery	Test Mode
EPE-EM6-ST-TL-IP-AT-3H	220-240VAC	200lm @2.5W Max/ 2W Max	24H/ ≥3H	Li-ion 3.7V 2200mA	Auto Test
EPE-EM6-ST-TL-IP-MT-3H	220-240VAC	200lm @2.5W Max/ 2W Max	24H/ ≥3H	Li-ion 3.7V 2200mA	Manual Test
EPE-EM6-ST-TL-IP-DA-3H	220-240VAC	200lm @2.5W Max/ 2W Max	24H/ ≥3H	Li-ion 3.7V 2200mA	DALI
EPE-EM6-HO-TL-IP-AT-3H	220-240VAC	400lm @1W Max/ 4W Max	24H/ ≥3H	Li-ion 3.7V 4400mA	Auto Test
EPE-EM6-HO-TL-IP-MT-3H	220-240VAC	400lm @1W Max/ 4W Max	24H/ ≥3H	Li-ion 3.7V 4400mA	Manual Test
EPE-EM6-HO-TL-IP-DA-3H	220-240VAC	400lm @1W Max/ 4W Max	24H/ ≥3H	Li-ion 3.7V 4400mA	DALI

Dimensions unit:mm

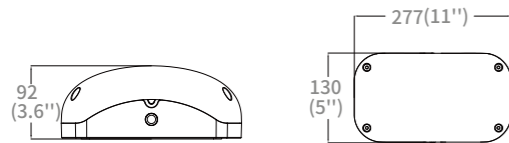

Color Options

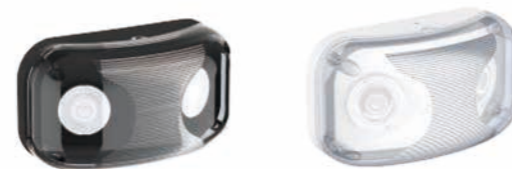

EPE-EM6B | LED Emergency Light



- Two rotatable LED lamp heads.
- High power and high lumen output.
- Elegant design, small volume and weight.
- The industry's first high-power emergency light with DALI function.
- LiFePO4 battery with better performance and longer life time.



▼ Model List

Model	Input Voltage	Mains/ Emergency Power	Charge/ Discharge Duration	Battery	Test Mode
EPE-EM6B-ST-AT-3H	200-240VAC	650lm @3.5W Max/ 4.5W Max	24H/ ≥3H	LiFePO4 6.4V3200mAh	Auto Test
EPE-EM6B-ST-MT-3H	200-240VAC	650lm @3.5W Max/ 4.5W Max	24H/ ≥3H	LiFePO4 6.4V3200mAh	Manual Test
EPE-EM6B-ST-DA-3H	200-240VAC	650lm @3.5W Max/ 4.5W Max	24H/ ≥3H	LiFePO4 6.4V3200mAh	DALI
EPE-EM6B-HO-AT-3H	200-240VAC	1200lm @6W Max/ 8W Max	24H/ ≥3H	LiFePO4 6.4V6000mAh	Auto Test
EPE-EM6B-HO-MT-3H	200-240VAC	1200lm @6W Max/ 8W Max	24H/ ≥3H	LiFePO4 6.4V6000mAh	Manual Test
EPE-EM6B-HO-DA-3H	200-240VAC	1200lm @6W Max/ 8W Max	24H/ ≥3H	LiFePO4 6.4V6000mAh	DALI

▼ Dimensions unit:mm

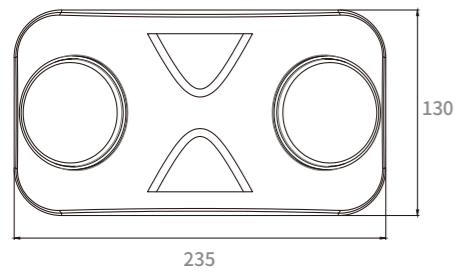

EPE-EM7 | LED Emergency Track Light



- White / Black finishing optional.
- Suitable for 4-wire 3-circuit track mounting.
- Intelligent IC control appliance.
- Push-to-test switch.



Model List

Model	Input Voltage	Mains/ Emergency Power	Charge/ Discharge Duration	Battery	Test Mode
EPE-EM7-AT-3H	220-240VAC	220lm @3.5W Max/ 2W Max	24H/ ≥3H	LiFePO4 6.4V1500mAh	Auto Test
EPE-EM7-MT-3H	220-240VAC	220lm @3.5W Max/ 2W Max	24H/ ≥3H	LiFePO4 6.4V1500mAh	Manual Test
EPE-EM7-DA-3H	220-240VAC	220lm @3.5W Max/ 2W Max	24H/ ≥3H	LiFePO4 6.4V1500mAh	DALI

Dimensions unit:mm

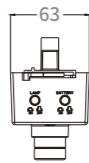
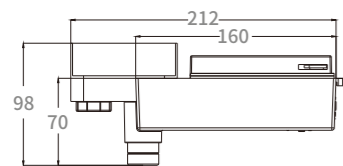

Color options



EPE-EM8 | LED Twinspot Emergency Light



- Two adjustable LED lamp heads.
- Round lens and oval Lens optional.
- 200lm & 400lm optional.
- Intelligent IC control appliance.



Model List

Model	Input Voltage	Mains/ Emergency Power	Charge/ Discharge Duration	Battery	Test Mode
EPE-EM8-ST-AT-3H	220-240VAC	200lm @2.5W Max/ 2W Max	24H/ ≥3H	Li-ion 3.7V2200mAh	Auto Test
EPE-EM8-ST-MT-3H	220-240VAC	200lm @2.5W Max/ 2W Max	24H/ ≥3H	Li-ion 3.7V2200mAh	Manual Test
EPE-EM8-HO-AT-3H	220-240VAC	400lm @4W Max/ 3W Max	24H/ ≥3H	Li-ion 3.7V4400mAh	Auto Test
EPE-EM8-HO-MT-3H	220-240VAC	400lm @4W Max/ 3W Max	24H/ ≥3H	Li-ion 3.7V4400mAh	Manual Test

Dimensions unit:mm

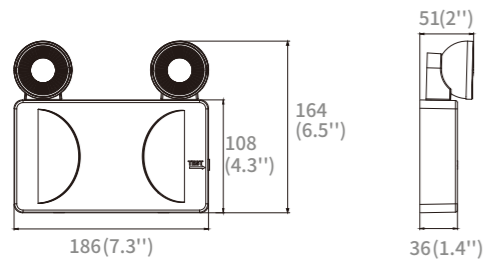

Lens



Oval Lens

Round Lens



EPE-EM9 | LED Emergency Downlight



- Aluminum material, high grade appearance design.
- Compact high performance IP65 Rated.
- 250lm & 550lm & 750lm optional.
- High power & efficiency LED.



▼ Model List

Model	Input Voltage	Mains/ Emergency Power	Charge/ Discharge Duration	Battery	Test Mode
EPE-EM9-LO-AT-3H	220-240VAC	250lm @2W Max/ 2W Max	24H/ ≥3H	LiFePO4 18650 6.4V 1500mAh	Auto Test
EPE-EM9-ST-AT-3H	220-240VAC	550lm @4W Max/ 4W Max	24H/ ≥3H	LiFePO4 26650 6.4V 3200mAh	Auto Test
EPE-EM9-HO-AT-3H	220-240VAC	750lm @6W Max/ 6W Max	24H/ ≥3H	LiFePO4 18650 6.4V 4500mAh	Auto Test

▼ Dimensions unit:mm

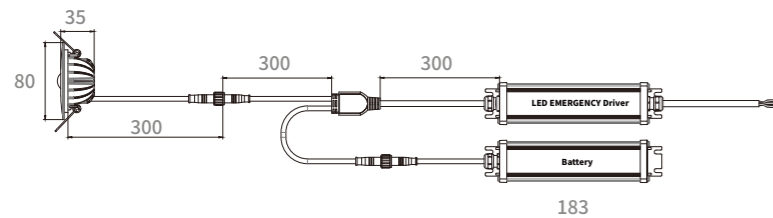

EPE-EM11 | DALI LED Emergency Track Light



- Suitable for 4-wire 3-circuit DALI track mounting.
- Intelligent IC control appliance.
- Convenient switch to control Maintained or Non-maintained.
- White / Black finishing optional.
- Push-to-test switch.
- Battery on/off switch can easy connect the battery, no need to tear down the frame.



Model List

Model	Input Voltage	Mains/ Emergency Power	Charge/ Discharge Duration	Battery	Test Mode
EPE-EM11-DA-3H	220-240VAC	250lm @2.5W Max/ 2W Max	24H/ ≥3H	LiFePO4 6.4V1500mAh	DALI

Dimensions unit:mm

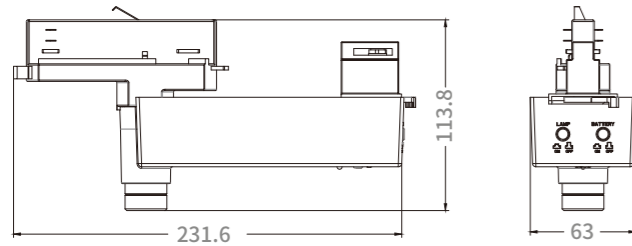

Color options



EPE-EM12 | LED Twinspot Emergency Light



- Ip65 rated durable PC Construction.
- Two adjustable LED lamp heads.
- 750lm/ 1000lm/ 1200lm/ 2000lm optional.
- Compact structure for easy installation.
- Ideal for commercial and industrial application.



Model List

Model	Input Voltage	Mains/ Emergency Power	Charge/ Discharge Duration	Battery	Test Mode
EPE-EM12-LO-AT-3H	220-240VAC	750lm @7W Max/ 5W Max	24H/ ≥3H	LiFePO4 6.4V3200mAh	Auto Test
EPE-EM12-LO-MT-3H	220-240VAC	750lm @7W Max/ 5W Max	24H/ ≥3H	LiFePO4 6.4V3200mAh	Manual Test
EPE-EM12-LO-DA-3H	220-240VAC	750lm @7W Max/ 5W Max	24H/ ≥3H	LiFePO4 6.4V3200mAh	DALI
EPE-EM12-ST-AT-3H	220-240VAC	1000lm @9W Max/ 9W Max	24H/ ≥3H	LiFePO4 6.4V6000mAh	Auto Test
EPE-EM12-ST-MT-3H	220-240VAC	1000lm @9W Max/ 9W Max	24H/ ≥3H	LiFePO4 6.4V6000mAh	Manual Test
EPE-EM12-ST-DA-3H	220-240VAC	1000lm @9W Max/ 9W Max	24H/ ≥3H	LiFePO4 6.4V6000mAh	DALI
EPE-EM12-HO-AT-3H	220-240VAC	1200lm @9W Max/ 9W Max	24H/ ≥3H	LiFePO4 6.4V6000mAh	Auto Test
EPE-EM12-HO-MT-3H	220-240VAC	1200lm @9W Max/ 9W Max	24H/ ≥3H	LiFePO4 6.4V6000mAh	Manual Test
EPE-EM12-HO-DA-3H	220-240VAC	1200lm @9W Max/ 9W Max	24H/ ≥3H	LiFePO4 6.4V6000mAh	DALI
EPE-EM12B-AT-3H	220-240VAC	2000lm @11W Max/ 14W Max	24H/ ≥3H	LiFePO4 12.8V6000mAh	Auto Test
EPE-EM12B-MT-3H	220-240VAC	2000lm @11W Max/ 14W Max	24H/ ≥3H	LiFePO4 12.8V6000mAh	Manual Test
EPE-EM12B-DA-3H	220-240VAC	2000lm @11W Max/ 14W Max	24H/ ≥3H	LiFePO4 12.8V6000mAh	DALI

Dimensions unit:mm

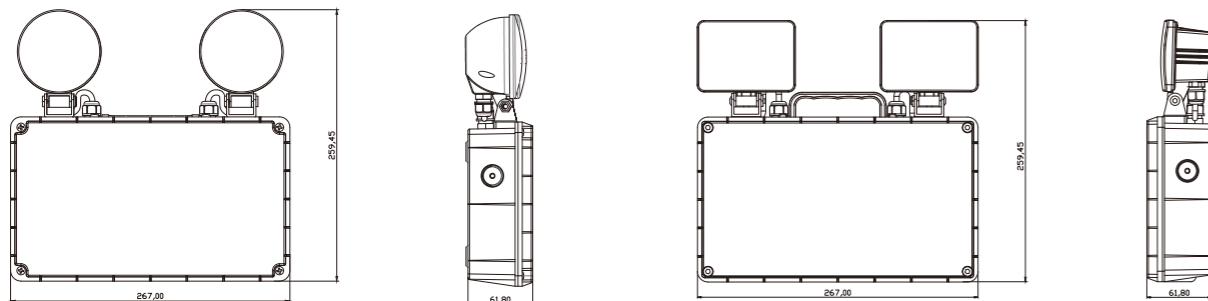

EUROPEAN

EMERGENCY DRIVER

EPE-ED1 | DALI LED Control Gear For Emergency Lighting



- DALI control gear.
- Battery backup unit provides 1H/ 3H duration during power failure.
- Constant power output, LiFePO4 battery with high performance.
- CE, CB, RoHS Certified.

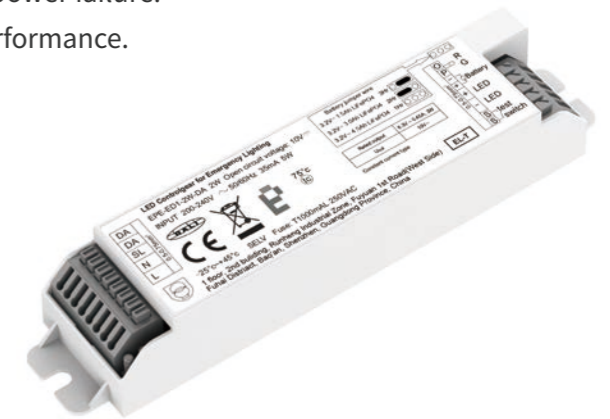

Model List

Model	Input Voltage	Mains/ Emergency Power	Charge/ Discharge Duration	Battery	Test Mode
EPE-ED1-1W-DA-3H	200-240VAC	4W Max/ 1W Max	24H/ ≥3H	LiFePO4 6.4V 1500mAh	DALI
EPE-ED1-2W-DA-3H	200-240VAC	4W Max/ 2W Max	24H/ ≥3H	LiFePO4 9.6V 1500mAh	DALI
EPE-ED1-4W-DA-3H	200-240VAC	4W Max/ 4W Max	24H/ ≥3H	LiFePO4 6.4V 4500mAh	DALI

Dimensions unit:mm





EPE-ED2 | Constant Current LED Emergency Inverter

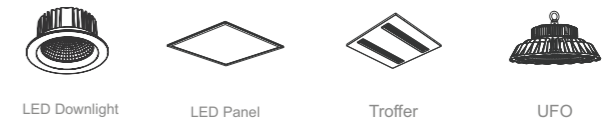

- Smart IC control, switch freely between charging and discharging mode.
- Built-out LiFePO4-battery, flexible, safe, stable and long lasting.
- Self-testing and self-diagnostic function optional.
- Constant current for 2W/ 4W/ 6W max output power.



Model List

Model	Input Voltage	Mains/ Emergency Power	Charge/ Discharge Duration	Battery	Test Mode
EPE-ED2/ED2B-LO-AT-3H	220-240VAC	3.5W Max/ 2W Max	24H/ ≥3H	LiFePO4 6.4V 1500mAh	Auto Test
EPE-ED2/ED2B-LO-MT-3H	220-240VAC	3.5W Max/ 2W Max	24H/ ≥3H	LiFePO4 6.4V 1500mAh	Manual Test
EPE-ED2/ED2B-ST-AT-3H	220-240VAC	6W Max/ 4W Max	24H/ ≥3H	LiFePO4 6.4V 3200mAh	Auto Test
EPE-ED2/ED2B-ST-MT-3H	220-240VAC	6W Max/ 4W Max	24H/ ≥3H	LiFePO4 6.4V 3200mAh	Manual Test
EPE-ED2/ED2B-HO-AT-3H	220-240VAC	6W Max/ 6W Max	24H/ ≥3H	LiFePO4 6.4V 4500mAh	Auto Test
EPE-ED2/ED2B-HO-MT-3H	220-240VAC	6W Max/ 6W Max	24H/ ≥3H	LiFePO4 6.4V 4500mAh	Manual Test

Dimensions unit:mm





EPE-ED3 | LED Emergency Driver



LED bulb



LED Tube

- Battery backup unit provides 2H/ 3H duration during power failure.
- High voltage with full power output.
- Suitable for LED tube and bulb.
- Ni-Cad/ LiFePO4 battery is optional.



Model List

Model	Input Voltage	Mains/ Emergency Power	Charge/ Discharge Duration	Battery	Test Mode
EPE-ED3-NC-20W-AT-3H	85-265VAC	8W Max/ 20W Max	24H/ ≥3H	NI-CD 12V 2300mAh*2	Manual Test
EPE-ED3-20W-AT-3H	85-265VAC	11W Max/ 20W Max	24H/ ≥3H	LiFePO4 12.8V 6400mAh	Auto Test
EPE-ED3-20W-MT-3H	85-265VAC	11W Max/ 20W Max	24H/ ≥3H	LiFePO4 12.8V 6400mAh	Manual Test

Dimensions unit:mm

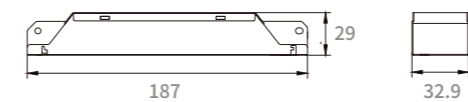



EPE-ED6 | Smart IC Control Dimming Inverter

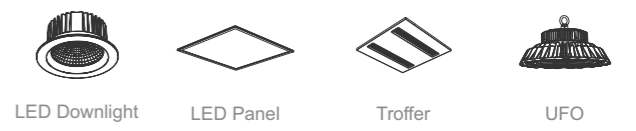

- 0-10V dimming, can support LED light which up to 200W.
- Suitable for LED lighting with high power.
- Wireless remote control for test, control distance over 30M.
- Convenient and fast wiring without external junction box.



Model List

Model	Input Voltage	Mains/ Emergency Power	Charge/ Discharge Duration	Battery	Test Mode
EPE-ED6-10W-AT-3H	220-240VAC	9W Max/ 10W Max	24H/ ≥3H	LiFePO4 9.6V 6000mAh	Auto Test
EPE-ED6-10W-MT-3H	220-240VAC	9W Max/ 10W Max	24H/ ≥3H	LiFePO4 9.6V 6000mAh	Manual Test
EPE-ED6A-10W-AT-3H	220-240VAC	9W Max/ 10W Max	24H/ ≥3H	LiFePO4 9.6V 6000mAh	Auto Test
EPE-ED6A-10W-MT-3H	220-240VAC	9W Max/ 10W Max	24H/ ≥3H	LiFePO4 9.6V 6000mAh	Manual Test
EPE-ED6-20W-AT-3H	220-240VAC	9W Max/ 20W Max	24H/ ≥3H	LiFePO4 9.6V 6000mAh	Auto Test
EPE-ED6-20W-MT-3H	220-240VAC	9W Max/ 20W Max	24H/ ≥3H	LiFePO4 9.6V 6000mAh	Manual Test
EPE-ED6A-20W-AT-3H	220-240VAC	9W Max/ 20W Max	24H/ ≥3H	LiFePO4 9.6V 6000mAh	Auto Test
EPE-ED6A-20W-MT-3H	220-240VAC	9W Max/ 20W Max	24H/ ≥3H	LiFePO4 9.6V 6000mAh	Manual Test

Dimensions unit:mm

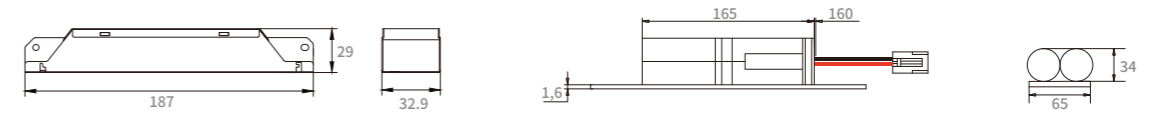



EPE-ED7 | LED Emergency Driver



LED Downlight



LED Panel



Troffer

- Smart IC control, switch freely between charging and discharging mode.
- Built-out LiFePO4-battery, flexible, safe, stable and long lasting.
- Self-testing and self-diagnostic function optional.
- Constant power for 2W/ 4W/ 8W max output power.



Model List

Model	Input Voltage	Mains/ Emergency Power	Charge/ Discharge Duration	Battery	Test Mode
EPE-ED7-LO-AT-3H	220-240VAC	2W Max/ 2W Max	24H/ ≥3H	LiFePO4 6.4V 1500mAh	Auto Test
EPE-ED7-LO-MT-3H	220-240VAC	2W Max/ 2W Max	24H/ ≥3H	LiFePO4 6.4V 1500mAh	Manual Test
EPE-ED7-LO-DA-3H	220-240VAC	2W Max/ 2W Max	24H/ ≥3H	LiFePO4 6.4V 1500mAh	DALI
EPE-ED7-ST-AT-3H	220-240VAC	4W Max/ 4W Max	24H/ ≥3H	LiFePO4 6.4V 3200mAh	Auto Test
EPE-ED7-ST-MT-3H	220-240VAC	4W Max/ 4W Max	24H/ ≥3H	LiFePO4 6.4V 3200mAh	Manual Test
EPE-ED7-ST-DA-3H	220-240VAC	4W Max/ 4W Max	24H/ ≥3H	LiFePO4 6.4V 3200mAh	DALI
EPE-ED7-HO-AT-3H	220-240VAC	6W Max/ 8W Max	24H/ ≥3H	LiFePO4 6.4V 6000mAh	Auto Test
EPE-ED7-HO-MT-3H	220-240VAC	6W Max/ 8W Max	24H/ ≥3H	LiFePO4 6.4V 6000mAh	Manual Test
EPE-ED7-HO-DA-3H	220-240VAC	6W Max/ 8W Max	24H/ ≥3H	LiFePO4 6.4V 6000mAh	DALI

Dimensions unit:mm

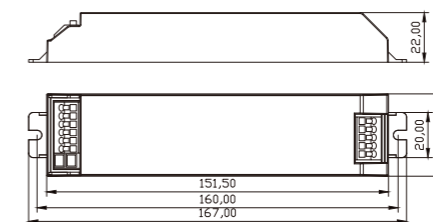



EPE-ED9 | LED Emergency Driver



LED Downlight

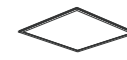

LED Panel



Troffer

- Smart IC control, switch freely between charging and discharging mode.
- Built-in LiFePO4-battery, flexible, safe, stable and long lasting.
- Self-testing and self-diagnostic function optional.
- Constant power for 2W max output power.



Model List

Model	Input Voltage	Mains/ Emergency Power	Charge/ Discharge Duration	Battery	Test Mode
EPE-ED9-AT-3H	220-240VAC	3.5W Max/ 2W Max	24H/ ≥3H	LiFePO4 6.4V1500mAh	Auto Test
EPE-ED9-MT-3H	220-240VAC	3.5W Max/ 2W Max	24H/ ≥3H	LiFePO4 6.4V1500mAh	Manual Test
EPE-ED9-DA-3H	220-240VAC	3.5W Max/ 2W Max	24H/ ≥3H	LiFePO4 6.4V1500mAh	DALI

Dimensions unit:mm



OCEANIA

EMERGENCY SIGN



EPA-EX1 | LED Exit Sign



- Pictogram replaceable.
- LiFePO4 battery, long life time.
- Non-maintained or maintained operation.
- Ideal for commercial and industrial applications.



Model List

Model	Input Voltage	Mains/ Emergency Power	Charge/ Discharge Duration	Battery	Test Mode
EPA-EX1-AT-2H	220-240VAC	3W Max/ 1W Max	16H/ ≥2H	LiFePO4 3.2V 600mAh	Auto Test
EPA-EX1-MT-2H	220-240VAC	3W Max/ 1W Max	16H/ ≥2H	LiFePO4 3.2V 600mAh	Manual Test
EPA-EX1-DA-2H	220-240VAC	3W Max/ 1W Max	16H/ ≥2H	LiFePO4 3.2V 600mAh	DALI

Dimensions unit:mm

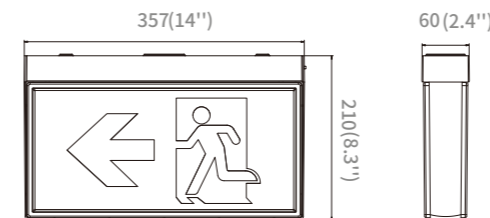

Appearance





EPA-EX2 | LED Exit Sign



- Easy-Connect installation.
- Low power consumption.
- Acrylic diffuser with pictogram legends.
- Non-maintained or maintained operation.



▼ Model List

Model	Input Voltage	Mains/ Emergency Power	Charge/ Discharge Duration	Battery	Test Mode
EPA-EX2-AT-2H	220-240VAC	3W Max/ 1W Max	16H/ ≥2H	LiFePO4 6.4V 600mAh	Auto Test
EPA-EX2-MT-2H	220-240VAC	3W Max/ 1W Max	16H/ ≥2H	LiFePO4 6.4V 600mAh	Manual Test
EPA-EX2-DA-2H	220-240VAC	3W Max/ 1W Max	16H/ ≥2H	LiFePO4 6.4V 600mAh	DALI

▼ Dimensions unit:mm

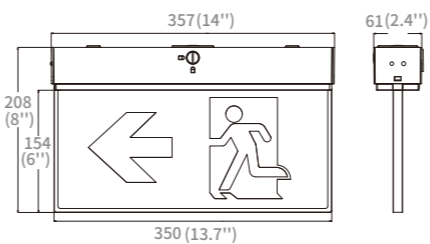

▼ Mounting Options



Ceiling / Wall Mounting Recessed Mounting



EPA-EX4A | LED Jumbo Exit Sign



- 1 X LED strips for single-sided pictogram.
- 2 X LED strips for double-sided pictograms.
- Anodized sheet steel housing with black or white colour.
- Maintained mode.
- Auto/ Manual/ DALI test.
- 32m/ 40m/ 48m/ 60m viewing distance. IP20 as standard.



▼ Model List

Model	Input Voltage	Mains/ Emergency Power	Charge/ Discharge Duration	Battery	Test Mode
EPA-EX4A-32M-AT-2H	220-240VAC	5W Max/ 2W Max	16H/ ≥2H	LiFePO4 6.4V 1500mAh	Auto Test
EPA-EX4A-32M-MT-2H	220-240VAC	5W Max/ 2W Max	16H/ ≥2H	LiFePO4 6.4V 1500mAh	Manual Test
EPA-EX4A-32M-DA-2H	220-240VAC	5W Max/ 2W Max	16H/ ≥2H	LiFePO4 6.4V 1500mAh	DALI
EPA-EX4A-40M-AT-2H	220-240VAC	5W Max/ 2W Max	16H/ ≥2H	LiFePO4 6.4V 1500mAh	Auto Test
EPA-EX4A-40M-MT-2H	220-240VAC	5W Max/ 2W Max	16H/ ≥2H	LiFePO4 6.4V 1500mAh	Manual Test
EPA-EX4A-40M-DA-2H	220-240VAC	5W Max/ 2W Max	16H/ ≥2H	LiFePO4 6.4V 1500mAh	DALI
EPA-EX4A-48M-AT-2H	220-240VAC	5W Max/ 2W Max	16H/ ≥2H	LiFePO4 6.4V 1500mAh	Auto Test
EPA-EX4A-48M-MT-2H	220-240VAC	5W Max/ 2W Max	16H/ ≥2H	LiFePO4 6.4V 1500mAh	Manual Test
EPA-EX4A-48M-DA-2H	220-240VAC	5W Max/ 2W Max	16H/ ≥2H	LiFePO4 6.4V 1500mAh	DALI
EPA-EX4A-60M-AT-2H	220-240VAC	9W Max/ 4.5W Max	16H/ ≥2H	LiFePO4 6.4V 3200mAh	Auto Test
EPA-EX4A-60M-MT-2H	220-240VAC	9W Max/ 4.5W Max	16H/ ≥2H	LiFePO4 6.4V 3200mAh	Manual Test
EPA-EX4A-60M-DA-2H	220-240VAC	9W Max/ 4.5W Max	16H/ ≥2H	LiFePO4 6.4V 3200mAh	DALI

▼ Dimensions unit:mm

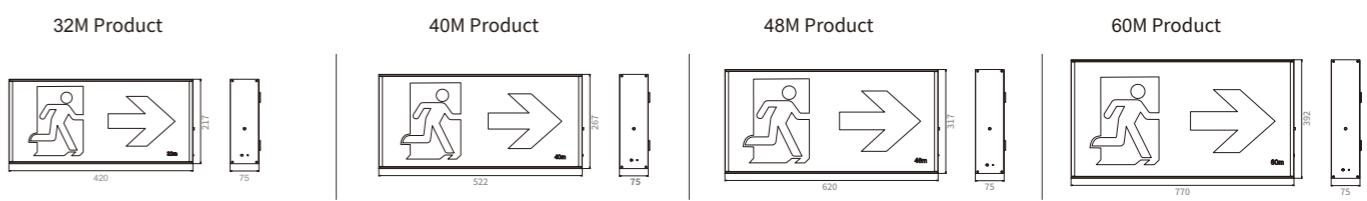

OCEANIA

EMERGENCY LIGHT

EPA-3W-EM

LED Emergency Downlight



- Round lens for open area application.
- Oval lens for escape route application.
- LiFePO4 battery, long life time.
- High power & efficiency LED.
- D63 Rating.



Model List

Model	Input Voltage	Mains/ Emergency Power	Charge/ Discharge Duration	Battery	Test Mode
EPA-3W-EM-AT-2H	200-240VAC	280lm @3.5W Max/ 3W Max	16H/ ≥2H	LiFePO4 6.4V1500mAh	Auto Test
EPA-3W-EM-MT-2H	200-240VAC	280lm @3.5W Max/ 3W Max	16H/ ≥2H	LiFePO4 6.4V1500mAh	Manual Test
EPA-3W-EM-DA-2H	200-240VAC	280lm @3.5W Max/ 3W Max	16H/ ≥2H	LiFePO4 6.4V1500mAh	DALI

Dimensions unit:mm

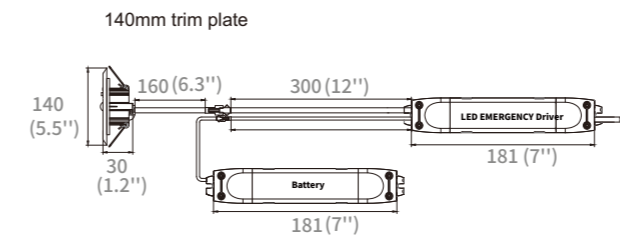

Appearance





EPA-3W-EM-SB | LED Surface Mounting Emergency Light



- Round lens for open area application.
- Oval lens for escape route application.
- LiFePO4 battery, long life time.
- High power & efficiency LED.
- D63 Rating.



Model List

Model	Input Voltage	Mains/ Emergency Power	Charge/ Discharge Duration	Battery	Test Mode
EPA-3W-EM-SB-AT-2H	200-240VAC	280lm @3.5W Max/ 3W Max	16H/ ≥2H	LiFePO4 6.4V1500mAh	Auto Test
EPA-3W-EM-SB-MT-2H	200-240VAC	280lm @3.5W Max/ 3W Max	16H/ ≥2H	LiFePO4 6.4V1500mAh	Manual Test
EPA-3W-EM-SB-DA-2H	200-240VAC	280lm @3.5W Max/ 3W Max	16H/ ≥2H	LiFePO4 6.4V1500mAh	DALI

Photometric Data

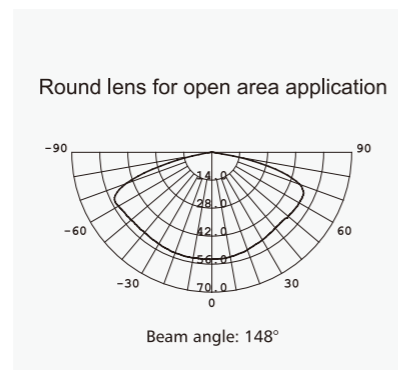
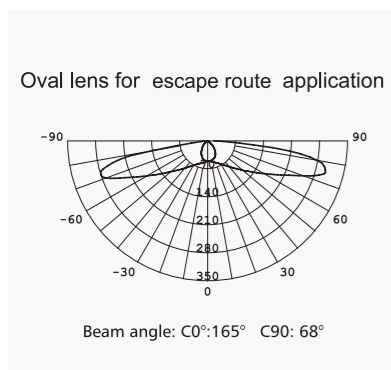

Dimensions unit:mm

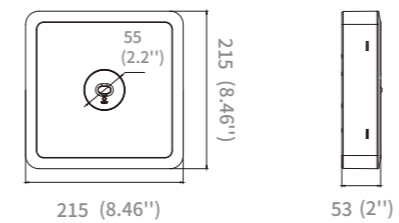

Appearance





ERIK

AMERICA

EMERGENCY SIGN

▼ Photometric Data

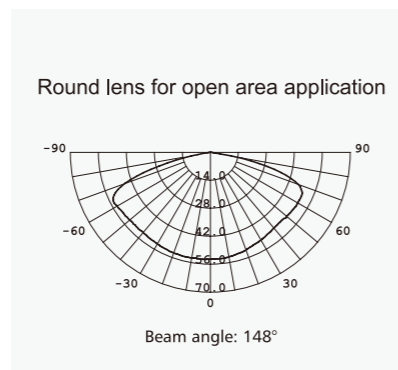
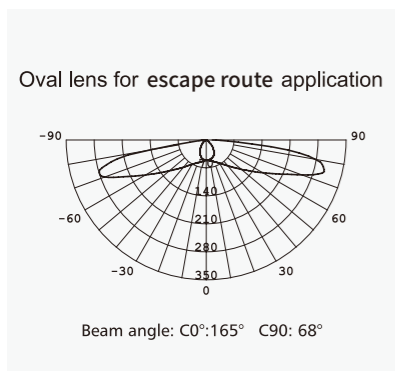

EPU-EX1 | LED Edge Lit Exit Sign



- Compact, decorative design.
- ELT listed | CEC title 20 Compliance.
- Suitable for single and double face applications.
- Attractive high-grade acrylic exit panel.
- Canopy for wall/ ceiling/ side mounting included.



Model List

Model	Input Voltage	Mains/ Emergency power	Charge/ Discharge Duration	Battery	Test Mode
EPU-EX1-AT-1.5H	120-277VAC	35lm @3W Max/ 3W Max	24H/ ≥1.5H	LiFePO4 6.4V600mAh	Auto Test
EPU-EX1-MT-1.5H	120-277VAC	35lm @3W Max/ 3W Max	24H/ ≥1.5H	LiFePO4 6.4V600mAh	Manual Test

Dimensions unit:mm/inch

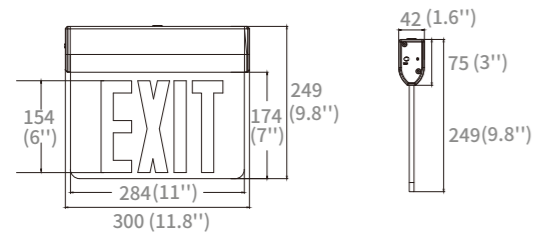

Color / Background / Mounting options



Mirror Background
Ceiling Mounting



Clear Background
Side Mounting



EPU-EX2 | LED Plastic Exit Sign



- Injection-molded thermoplastic housing.
- ETL listed, CEC title 20 compliance.
- Innovative, snap-together design allows for fast installation.
- Snap-out right and left directional arrows.
- Canopy for wall/ ceiling/ side mounting included.



Model List

Model	Input Voltage	Mains/ Emergency power	Charge/ Discharge Duration	Battery	Test Mode
EPU-EX2-MT-1.5H	120-277VAC	30lm @2W Max/ 0.5W Max	24H/ ≥1.5H	NI-CD 3.6V900mAh	Manual Test

Dimensions unit:mm/inch

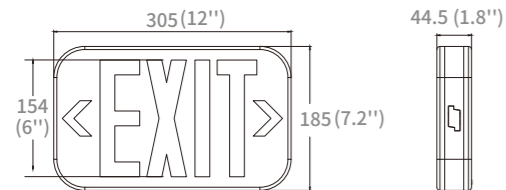

Color / Mounting Options



Side Mounting



Ceiling / Wall Mounting





- High-rated weatherproof.
- Suitable for wet locations.
- High durability & reliability.
- Auto test & manual test optional.
- Wall/ ceiling/ side mounting universal.



Model List

Model	Input Voltage	Mains/ Emergency power	Charge/ Discharge Duration	Battery	Test Mode
EPU-EX3-G-MT-1.5H	120-277VAC	30lm @3W Max/ 3W Max	24H/ ≥1.5H	NI-CD 3.6V900mAh	Manual Test

Dimensions unit:mm/inch

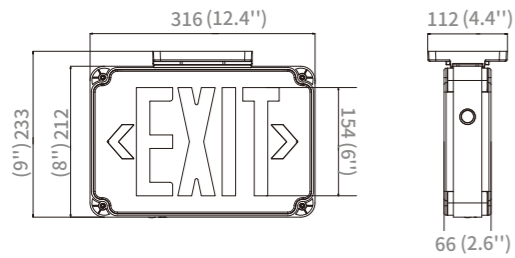

Appearance



EPU-EX4 | LED Edge Lit Exit Sign



- Compact, decorative design.
- ETL Listed, CEC title 20 Compliance.
- Suitable for single and double face applications.
- Attractive high-grade acrylic exit panel.



Model List

Model	Input Voltage	Mains/ Emergency power	Charge/ Discharge Duration	Battery	Test Mode
EPU-EX4-AT-1.5H	120-277VAC	30lm @3W Max/ 3W Max	24H/ ≥1.5H	NI-CD 3.6V900mAh	Auto Test
EPU-EX4-MT-1.5H	120-277VAC	30lm @3W Max/ 3W Max	24H/ ≥1.5H	NI-CD 3.6V900mAh	Manual Test

Dimensions unit:mm/inch

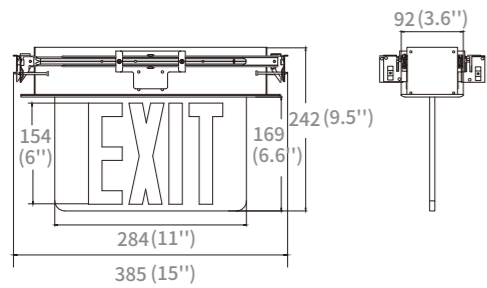

Color / Background options

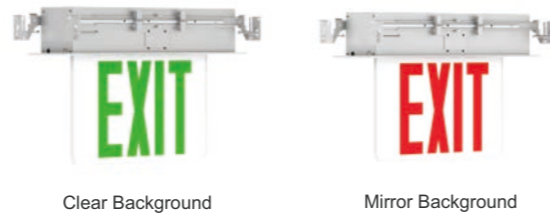

AMERICA

EMERGENCY LIGHT

EPU-CB1 | LED Exit and Emergency Combo



- Two fully adjustable, glare-free square light heads for emergency light.
- Injection-molded thermoplastic housing.
- ETL listed, CEC title 20 Compliance.
- High lumen output/ remote capability for option.
- Round lens for open area, oval lens for escaperoute application.



Model List

Model	Input Voltage	Mains/ Emergency power	Charge/ Discharge Duration	Battery	Test Mode
EPU-CB1-ST-AT-1.5H	120-277VAC	30lm @4.5W Max/ 3W Max	24H/ ≥1.5H	NI-CD 3.6V 900mAh	Auto Test
EPU-CB1-ST-MT-1.5H	120-277VAC	30lm @4.5W Max/ 3W Max	24H/ ≥1.5H	NI-CD 3.6V 900mAh	Manual Test
EPU-CB1-HO-AT-1.5H	120-277VAC	30lm @4.5W Max/ 3W Max	24H/ ≥1.5H	NI-CD 3.6V 900mAh*2	Auto Test
EPU-CB1-HO-MT-1.5H	120-277VAC	30lm @4.5W Max/ 3W Max	24H/ ≥1.5H	NI-CD 3.6V 900mAh*2	Manual Test

Dimensions unit:mm/inch

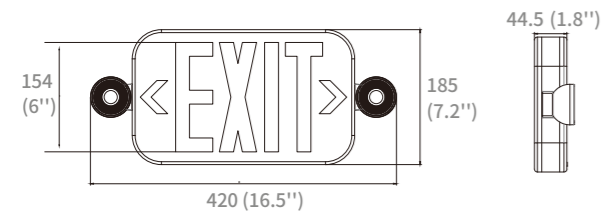

Color / Mounting Options



EPU-EM1 | LED Emergency Light



- Two fully adjustable, glare-free square light heads for emergency light.
- Injection-molded thermoplastic housing.
- ETL Listed, CEC title 20 Compliance.
- High lumen output / remote capability for option.
- Round lens for open area, oval lens for escape route application.



Model List

Model	Input Voltage	Mains/ Emergency power	Charge/ Discharge Duration	Battery	Test Mode
EPU-EM1-ST-AT-1.5H	120-277VAC	100lm @4.5W Max/ 3W Max	24H/ ≥1.5H	NI-CD 3.6V 900mAh	Auto Test
EPU-EM1-ST-MT-1.5H	120-277VAC	100lm @4.5W Max/ 3W Max	24H/ ≥1.5H	NI-CD 3.6V 900mAh	Manual Test
EPU-EM1-HO-AT-1.5H	120-277VAC	200lm @4.5W Max/ 3W Max	24H/ ≥1.5H	NI-CD 3.6V 900mAh*2	Auto Test
EPU-EM1-HO-MT-1.5H	120-277VAC	200lm @4.5W Max/ 3W Max	24H/ ≥1.5H	NI-CD 3.6V 900mAh*2	Manual Test

Dimensions unit:mm/inch

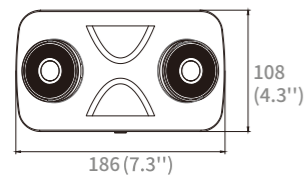

Lens



Oval Lens

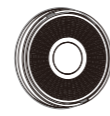

Round Lens



Photometric Data

Oval lens for escape route application

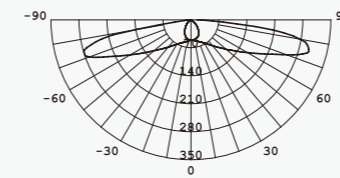

Beam angle: C0°:165° C90°:68°

Round lens for open area application

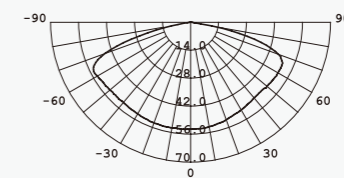

Beam angle: 148°

EPU-EM1-IP

LED Wet Location Emergency Light



- Two fully adjustable, glare-free square light heads for emergency light.
- Injection-molded thermoplastic housing.
- ETL Listed, CEC title 20 Compliance.
- LED indicator light and test switch.
- Round lens for open area, oval lens for escape route application.



Model List

Model	Input Voltage	Mains/ Emergency power	Charge/ Discharge Duration	Battery	Test Mode
EPU-EM1-ST-IP-AT-1.5H	120-277VAC	100lm @4.5W Max/ 3W Max	24H/ ≥1.5H	NI-CD 3.6V 900mAh	Auto Test
EPU-EM1-ST-IP-MT-1.5H	120-277VAC	100lm @4.5W Max/ 3W Max	24H/ ≥1.5H	NI-CD 3.6V 900mAh	Manual Test
EPU-EM1-HO-IP-AT-1.5H	120-277VAC	200lm @4.5W Max/ 3W Max	24H/ ≥1.5H	NI-CD 3.6V 900mAh*2	Auto Test
EPU-EM1-HO-IP-MT-1.5H	120-277VAC	200lm @4.5W Max/ 3W Max	24H/ ≥1.5H	NI-CD 3.6V 900mAh*2	Manual Test

Dimensions unit:mm/inch

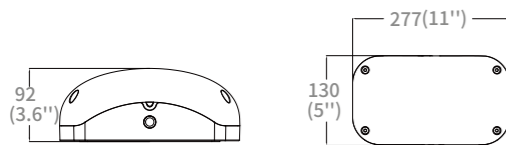

Color Options



Photometric Data

Oval lens for escape route application

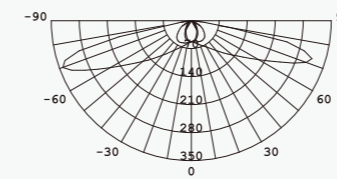

Beam angle: C0:163° C90: 61°

Round lens for open area application

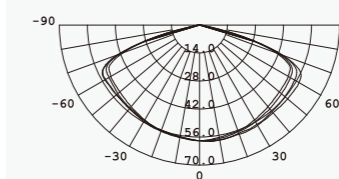

Beam angle: 148°

EPU-EM2 | LED Emergency Light



- Two fully adjustable, glare-free square light heads for emergency light.
- Injection-molded thermoplastic housing.
- ETL Listed, CEC title 20 Compliance.



Model List

Model	Input Voltage	Mains/ Emergency power	Charge/ Discharge Duration	Battery	Test Mode
EPU-EM2-ST-AT-1.5H	120-277VAC	100lm @4.5W Max/ 3W Max	24H/ ≥1.5H	NI-CD 3.6V 900mAh	Auto Test
EPU-EM2-ST-MT-1.5H	120-277VAC	100lm @4.5W Max/ 3W Max	24H/ ≥1.5H	NI-CD 3.6V 900mAh	Manual Test
EPU-EM2-HO-AT-1.5H	120-277VAC	200lm @4.5W Max/ 3W Max	24H/ ≥1.5H	NI-CD 3.6V 900mAh*2	Auto Test
EPU-EM2-HO-MT-1.5H	120-277VAC	200lm @4.5W Max/ 3W Max	24H/ ≥1.5H	NI-CD 3.6V 900mAh*2	Manual Test

Dimensions unit:mm/inch

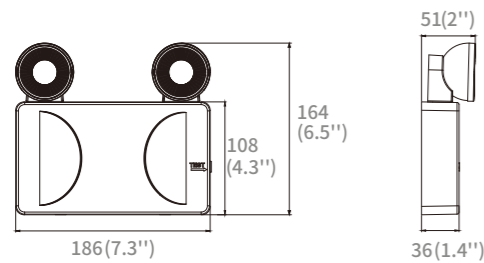

Lens

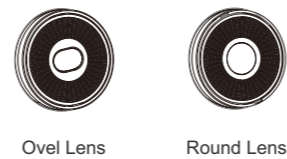

Ovel Lens

Round Lens

AMERICA

EMERGENCY DRIVER

EPU-ED1 | Low Voltage Constant Power LED Emergency Driver

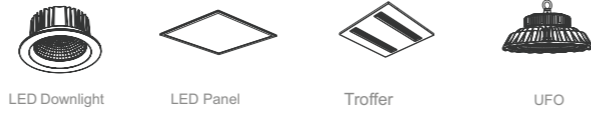

- Optional emergency power 8W, 12W, 25W
- Listed for field installation UL924 and CSA C22.2 NO.141
- Smart IC control constant output power
- High-temperature, maintenance-free, long life time LiFePO4 battery
- Temperature rating ambient:50°C
- High-efficiency for CEC title 20 compliance
- Manual test or Auto test function available



Model List

Model	Input Voltage	Mains/ Emergency power	Charge/ Discharge Duration	Battery	Test Mode
EPU-ED1-8W-LV-AT-1.5H	100-277VAC	5W Max/ 8W Max	24H/ ≥1.5H	LiFePO4 6.4V3300mAh	Auto Test
EPU-ED1-8W-LV-MT-1.5H	100-277VAC	5W Max/ 8W Max	24H/ ≥1.5H	LiFePO4 6.4V3300mAh	Manual Test
EPU-ED1-12W-LV-AT-1.5H	100-277VAC	7W Max/ 12W Max	24H/ ≥1.5H	LiFePO4 9.6V3300mAh	Auto Test
EPU-ED1-12W-LV-MT-1.5H	100-277VAC	7W Max/ 12W Max	24H/ ≥1.5H	LiFePO4 9.6V3300mAh	Manual Test
EPU-ED1-25W-LV-AT-1.5H	100-277VAC	9W Max/ 25W Max	24H/ ≥1.5H	LiFePO4 9.6V6600mAh	Auto Test
EPU-ED1-25W-LV-MT-1.5H	100-277VAC	9W Max/ 25W Max	24H/ ≥1.5H	LiFePO4 9.6V6600mAh	Manual Test

Dimensions unit:mm/inch

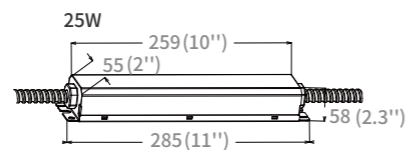
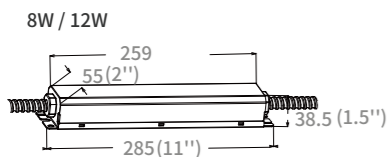

EPU-ED2 | High Voltage Output LED Emergency Driver



- Optional emergency power 8W, 12W, 25W.
- Listed for field installation UL924 and CSA C22.2 NO.141, meet CEC Title 20 Compliant.
- 170V output version for the LED Light with Internal Driver and power is \leq the EMB's.
- Self testfunction available.
- Low-maintenance, long life time LiFePO4 battery.



Model List

Model	Input Voltage	Mains/ Emergency power	Charge/ Discharge Duration	Battery	Test Mode
EPU-ED2-8W-AT-1.5H	100-277VAC	5W Max/ 8W Max	24H/ \geq 1.5H	LiFePO4 6.4V3300mAh	Auto Test
EPU-ED2-8W-MT-1.5H	100-277VAC	5W Max/ 8W Max	24H/ \geq 1.5H	LiFePO4 6.4V3300mAh	Manual Test
EPU-ED2-12W-AT-1.5H	100-277VAC	6W Max/ 12W Max	24H/ \geq 1.5H	LiFePO4 9.6V3300mAh	Auto Test
EPU-ED2-12W-MT-1.5H	100-277VAC	6W Max/ 12W Max	24H/ \geq 1.5H	LiFePO4 9.6V3300mAh	Manual Test
EPU-ED2-25W-AT-1.5H	100-277VAC	12W Max/ 25W Max	24H/ \geq 1.5H	LiFePO4 9.6V6600mAh	Auto Test
EPU-ED2-25W-MT-1.5H	100-277VAC	12W Max/ 25W Max	24H/ \geq 1.5H	LiFePO4 9.6V6600mAh	Manual Test

Dimensions unit:mm/inch

